

SERIE 600 Linea per ante di vetro in linea

SERIES 600 Line for aligned glass doors

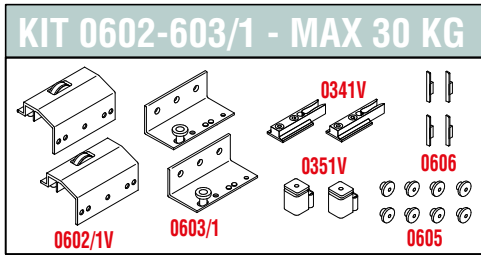



Sistemi scorrevoli per mobili / Sliding systems for furniture



Legenda KIT / Kit Legend

0602/1V	Carrello superiore per ante di vetro <i>Upper truck for glass doors</i>
0603/1	Guida inferiore <i>Lower guide</i>
0341V	Fermo superiore <i>Upper stopper</i>
0351V	Fermo inferiore <i>Lower stopper</i>
0605	Borchia ferro zincata <i>Iron stud</i>
0606	Tappo terminale per art.0604 <i>End plug for art.0604</i>

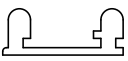
Legenda altri componenti Legend other items

0600	 Profilo alluminio superiore <i>Upper aluminium profile</i>
0601	 Profilo alluminio inferiore <i>Lower aluminium profile</i>
0604	 Profilo copertura alluminio <i>Cover aluminium profile</i>

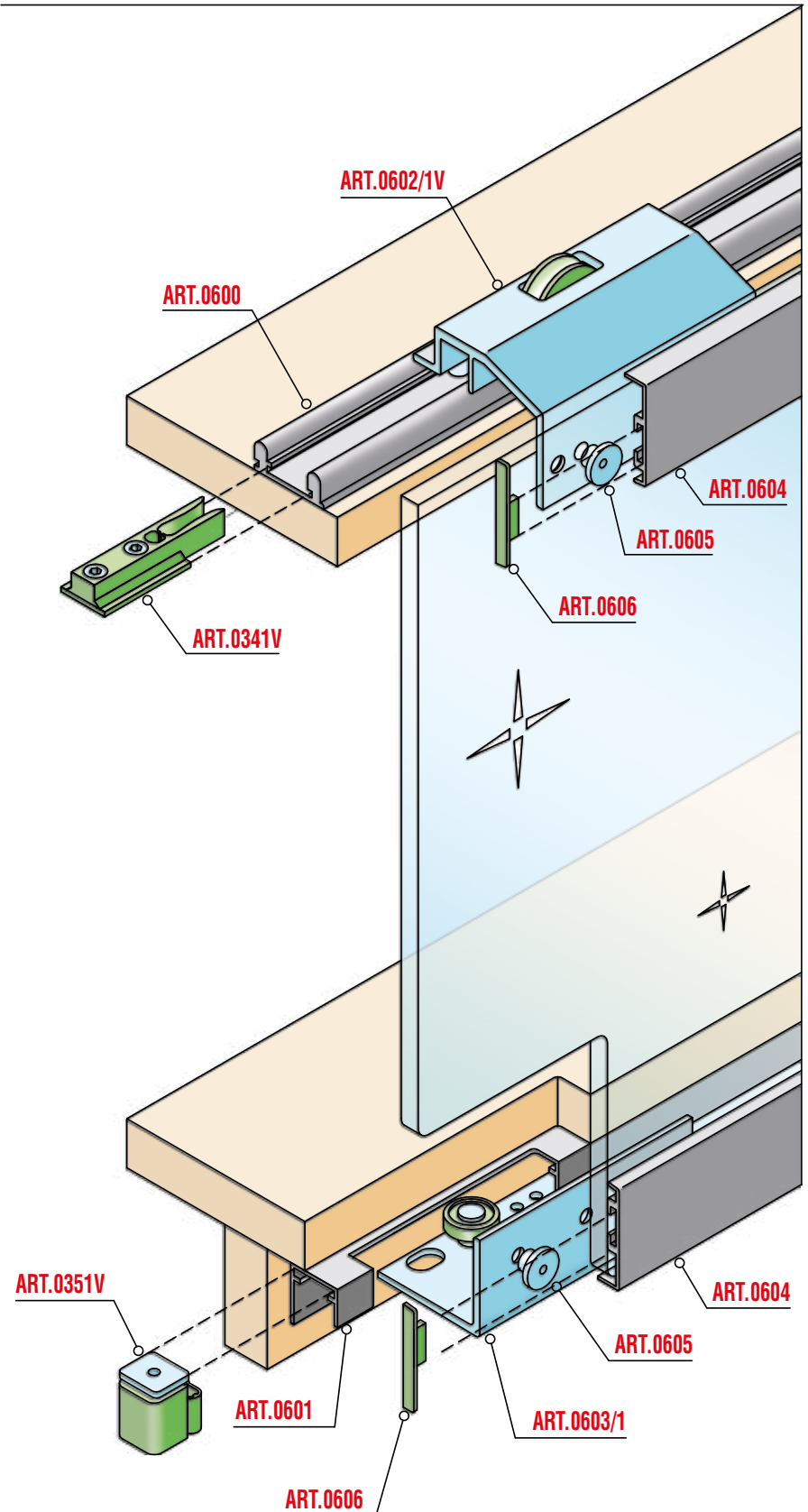



Sistemi scorrevoli per mobili / Sliding systems for furniture

Sezione verticale / Vertical section

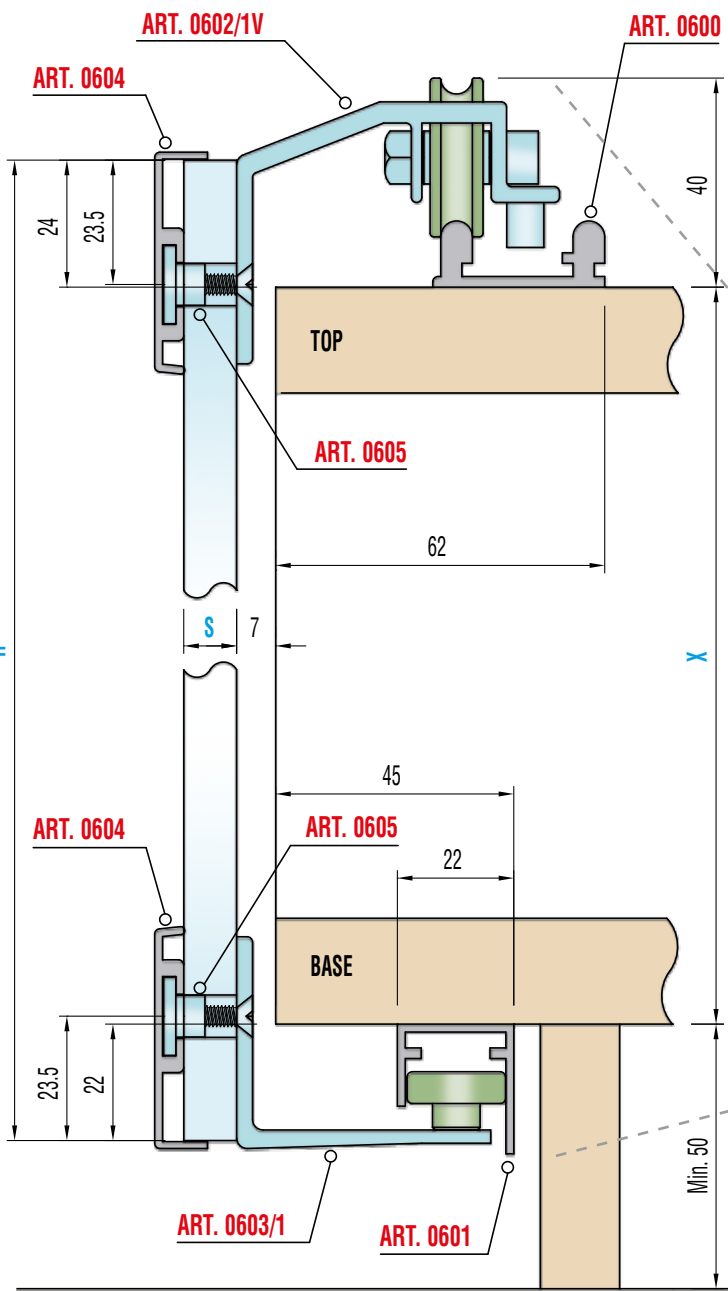

H =	X + 46
-----	--------

S (spessore / thickness)
min. 16 - max 25

Peso massimo anta Kg 30.
Maximum door weight Kg 30.

Variante Special version

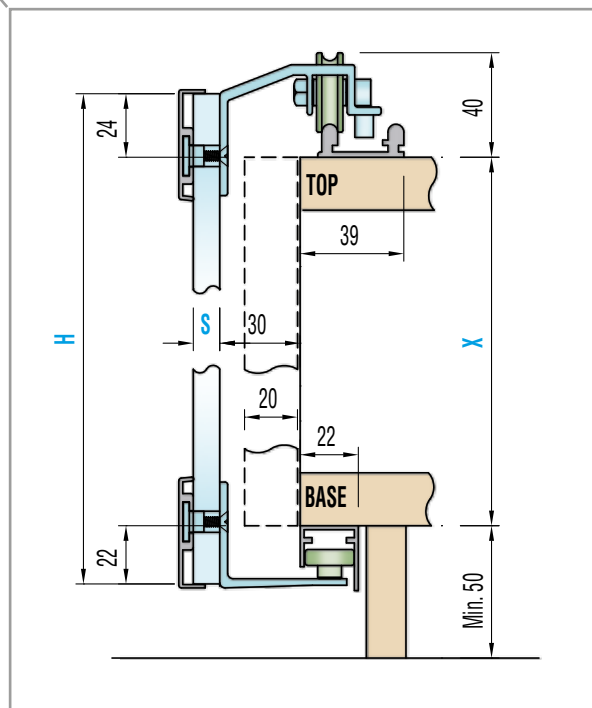

Schema Foratura ante / Doors drilling

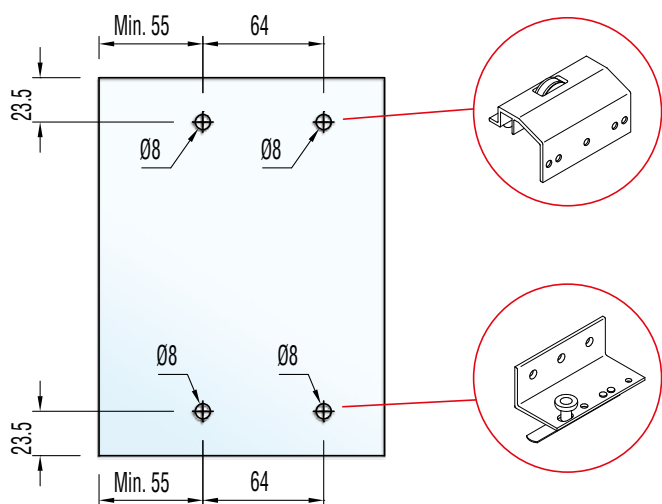

Schema di montaggio / Assembling

